

SHELVING

SHELVING
ACCESSORIES

TROLLEYS

HARDWARE

BARWARE

KITCHEN
EQUIPMENT

HOSPITALITY
FURNITURE

MANTOVA

SHELVING ACCESSORIES



Shelf Ledges

Simple and effective M-Span shelf ledges are extremely easy to install and provide a barrier along the perimeter of the shelves.

Made from polypropylene and stainless steel 4mm wire.



Part No.	Description / Size	Finish
# MSBL600	Back - 600mm	All are Stainless Steel with Polypropylene Brackets
# MSBL750	Back - 750mm	
# MSBL900	Back - 900mm	
# MSBL1050	Back - 1050mm	
# MSBL1200	Back - 1200mm	
# MSBL1350	Back - 1350mm	
# MSBL1500	Back - 1500mm	
# MSBL310	Side - 310mm	
# MSBL460	Side - 460mm	
# MSBL610	Side - 610mm	

Shelf Clips

Stainless Steel Bridging Clips can be used to provide clear access to corner shelving systems and additional add on bays. Clips are available on M-Span, Real Tuff and Wire Shelving.

- ▶ Two Bridging Clips are fitted to each shelf to eliminate two posts.
- ▶ Weight loading of:
150kg for shelves up to 1200mm long
100kg for shelves 1350 to 1800mm long.



Bridging Clip

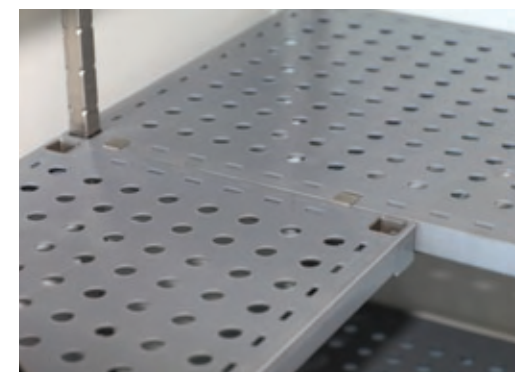

Clear reach access



Part No.	Description	Finish
# 0327M	M-SPAN Shelf Clips	Stainless Steel
# 0327	Real Tuff Shelf Clips	Stainless Steel
# 0327	Wire Grid Shelf Clips	Stainless Steel

Shelving Accessories

PRODUCT STOP

Available for 1, 2, 3 or 4 sides of the shelving or dunnage unit.

Can be made to suit all shelf sizes.

- ▶ **FINISH**
- Zinc
- Stainless Steel



POST CLAMPS

Post Clamps are designed to structurally reinforce adjoining shelving units setup to store heavy loads. Also useful for securing tall narrow units and to keep shelves aligned in confined spaces.



Post Clamps



Heavy Duty Applications

Part No.	Description	Finish
# 330	Post Clamp	Zinc

SHELF DIVIDERS

Dividers clip into front and rear of shelf.

- ▶ Suitable for shelves:
 - M-SPAN
 - Real Tuff
 - Wire
- ▶ Depth to suit shelf size

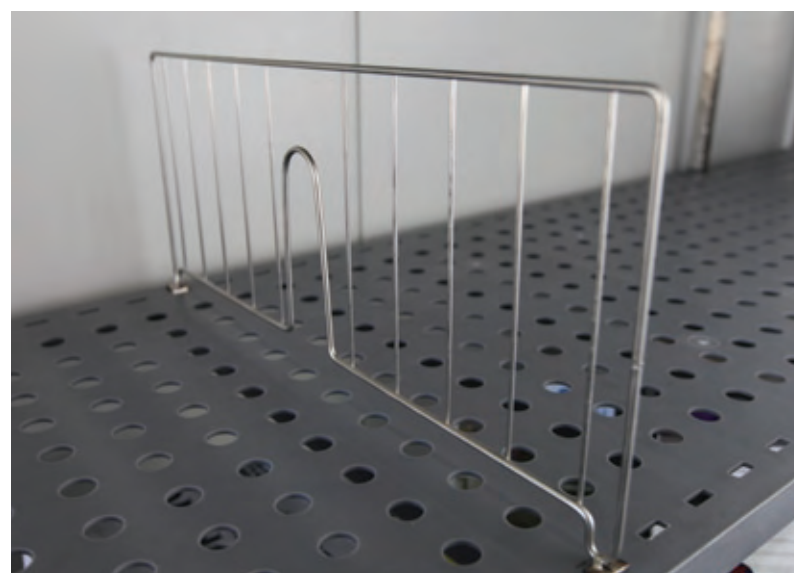

WALL FIX BRACKET

Used for fixing shelving to a wall for added stability.

Available in 2 lengths



Part No.	Description	Length	Finish
# PWFBS60	Wall Fix Bracket	60mm	Stainless Steel
# PWFBS150		150mm	

Part No.	Size	Finish
# SDIV450	450 x 250mm	Stainless Steel
# SDIV525	525 x 250mm	
# SDIV600	600 x 250mm	
# ZDIV450	450 x 250mm	Zinc Plated
# ZDIV525	525 x 250mm	
# ZDIV600	600 x 250mm	

Security Cage

Security Shelving allows storage and movement of costly items with safety and security. Heavy duty mesh panels secure the sides and back. Doors are pry resistant and can be padlocked.

▶ **SHELF OPTIONS**

- M-Span Shelves
- Wire Shelves
- Wire and Real Tuff shelves

▶ **CAGE**

4mm Wires spaced at 45mm

▶ **DIMENSIONS O/A**

Doors and side panels add 50mm to length and width of standard Mantova shelving sizes which you base your Security Cage upon.

O/A HEIGHT

1800mm plus Castors if fitted

▶ **OPTIONS**

- Choice of how many Tiers
- Can be fitted with a Mantova Wine Rack
- Can be made mobile on 125mm castors or s/s disc feet.

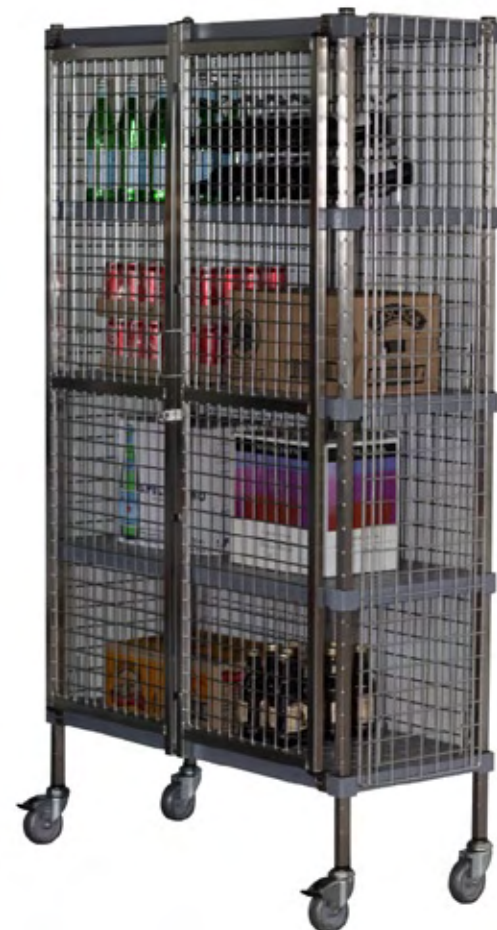

Part No.	Size (mm)	Finish	Details
# ZSC9045	900 x 450 x 1800	Zinc	Standard Cages: ▶ 5 tiers of shelves ▶ Posts 25mm x 25mm x 1.2mm tube fitted with a Mantova bullet foot allowing 32mm of adjustment.
# ZSC10545	1050 x 450 x 1800		
# ZSC12045	1200 x 450 x 1800		
# ZSC13545	1350 x 450 x 1800		
# ZSC9060	900 x 600 x 1800		
# ZSC10560	1050 x 600 x 1800		
# ZSC12060	1200 x 600 x 1800	Stainless Steel	
# ZSC13560	1350 x 600 x 1800		
# SSC9045	900 x 450 x 1800		
# SSC10545	1050 x 450 x 1800		
# SSC12045	1200 x 450 x 1800		
# SSC13545	1350 x 450 x 1800		
# SSC9060	900 x 600 x 1800		
# SSC10560	1050 x 600 x 1800		
# SSC12060	1200 x 600 x 1800		
# SSC13560	1350 x 600 x 1800		
# MSC	M-SPAN Security Cages to be quoted		



Safe Shelf

Add security to your Mantova Post Wire Shelving with a Safe Shelf. Panels are fastened to existing locations, no drilling is required, to secure half your bay of shelving. The Safe Shelf is suitable for both a new assembly and upgrading an existing shelving unit.

▶ **SHELF FRAMES**

Welded 32mm x 2.5mm roll formed section with 4mm wires on 8mm cross supports spaced on 25mm centres

▶ **POSTS**

25mm x 25mm x 1.2mm tube fitted with a Mantova bullet foot allowing 32mm of adjustment.

▶ **CAGE**

4mm Wires spaced at 45mm

▶ **DIMENSIONS O/A**

Doors and side panels add 50mm to length and width of standard Mantova shelving sizes which you base your Safe Shelf upon.

▶ **OPTIONS**

- Choice of how many Tiers*
- Can be fitted with a Mantova Wine Rack

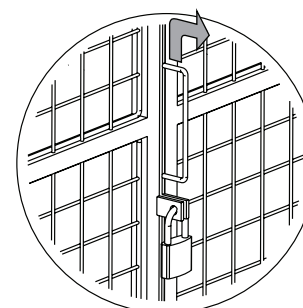

To open doors, simply lift and pull handle in one movement. (Padlock not supplied)

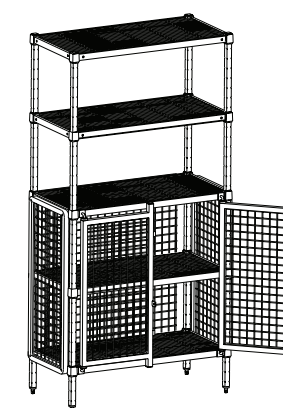
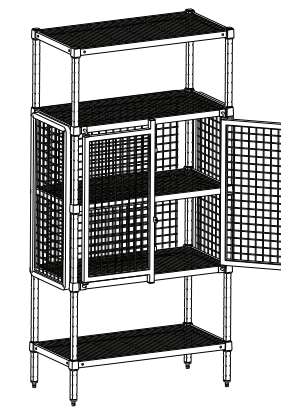
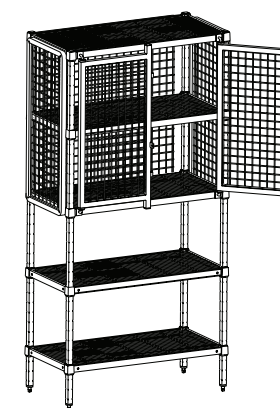

Safe Shelf Sizes

Widths (mm)	Lengths (mm)	Finishes	Standard Height
450	900, 1050, 1200 and 1350mm	Zinc Lacquered	5 tiers of shelves*
600		Polished Stainless Steel	



Bulk Wine Storage Racks

Available within a shelving unit or stand alone.

- ▶ Bulk Wine rack modules have five levels each accommodating 12 bottles.
- ▶ Can be housed in:
1200 x 300mm x 1200mm high Shelving to house two (2) modules or
or
1200 x 300 x 2000mm high shelving for four (4) modules giving 240 bottle storage.
- ▶ **STANDARD FINISH**
- Black Powder Coat

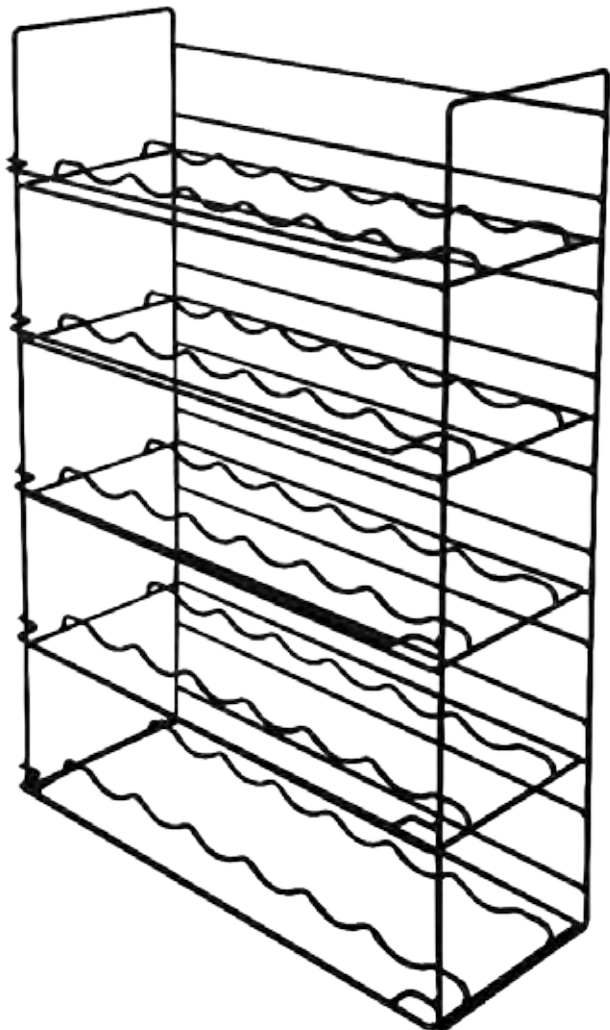

Bulk Wine Storage Racks can also be fitted into a Mantova Security Cage



Bulk Wine Racks with Shelf Frame

Part No.	Length	Width	Height	Capacity	Finish
# 603010-B	600	300	1000	60	Black Powder Coat
# 603020-B	600	300	2000	120	
# 123010-B	1200	300	1000	120	
# 123020-B	1200	300	2000	240	

Bulk Wine Rack (No Shelving Frame)

Part No.	Length	Width	Height	Capacity	Finish
# BMWW	600	300	850	60	Black Powder Coat



MANTOVA

QUALITY | STRENGTH | VALUE

WWW.MANTOVA.COM.AU